

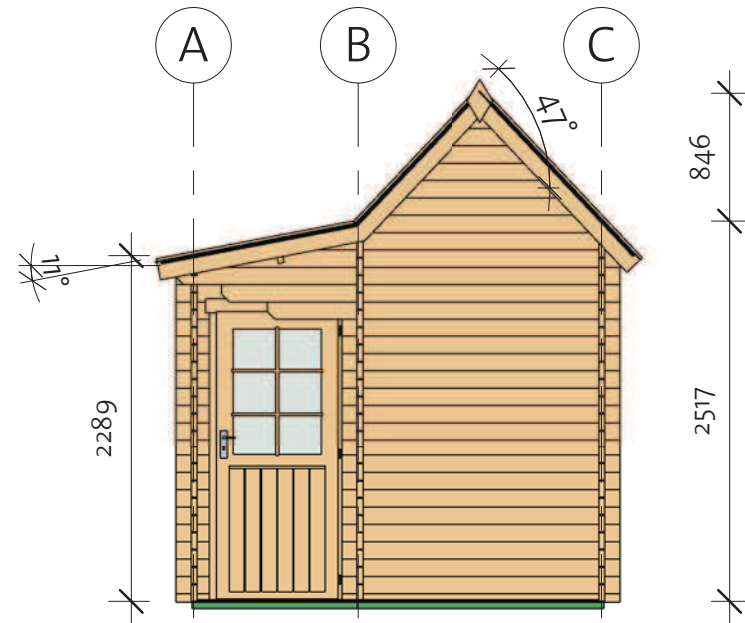

Laker Shed B 40 (274x454)

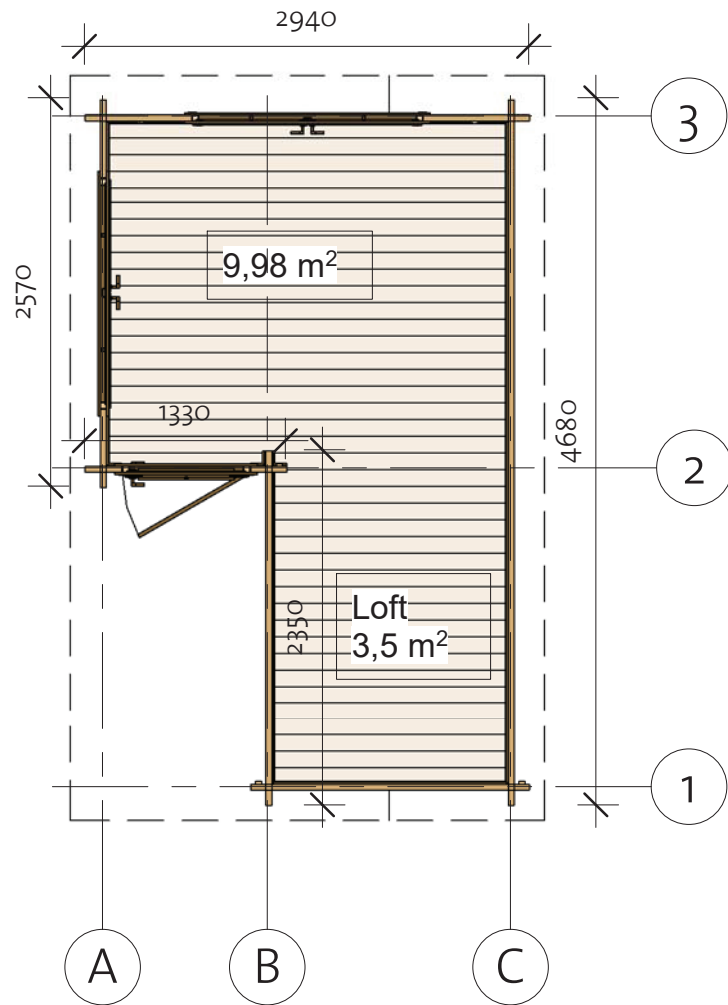
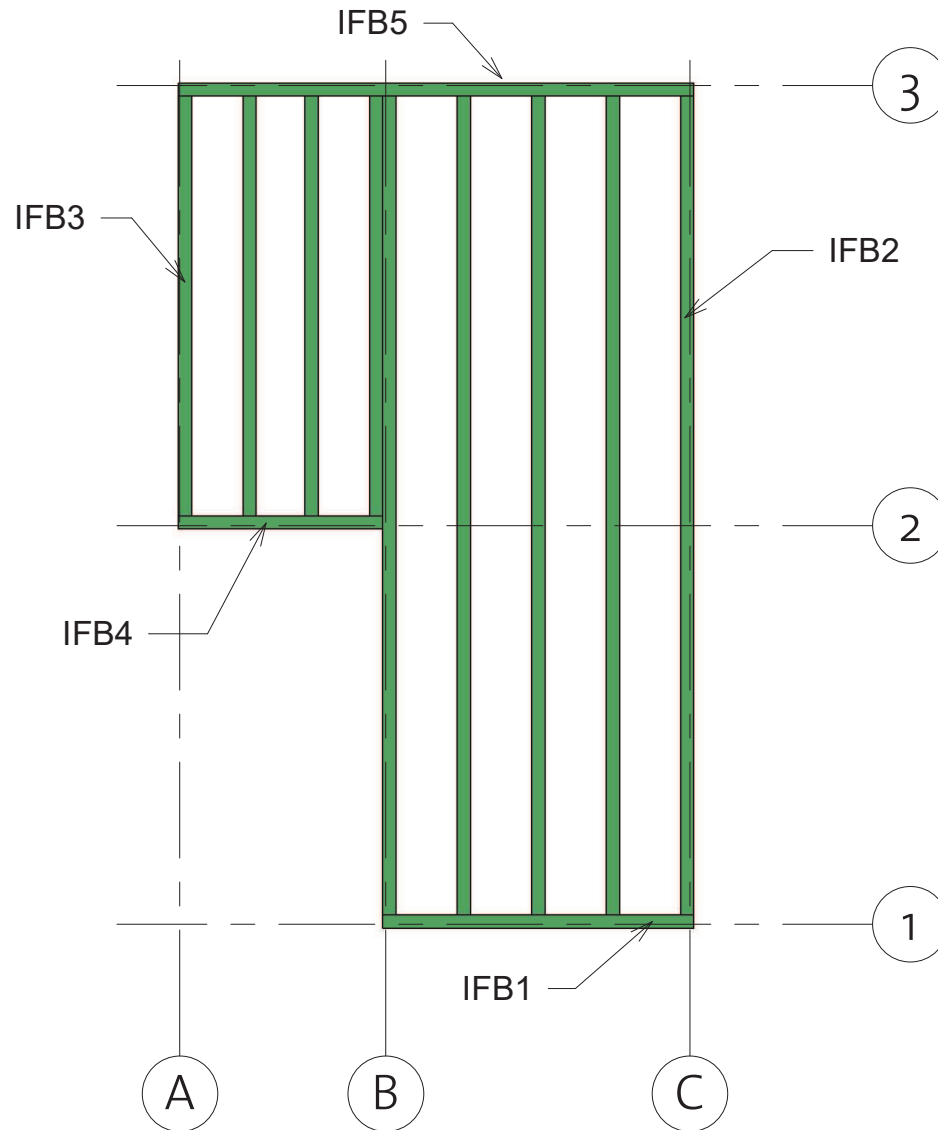

Laker Shed B 40 (274x454)

Foundation



Impregnated foundation beams				
Mark	Type	Profile	Count	Length
IFB1	IFB 70x40		1	1640
IFB2	IFB 70x40		5	4330
IFB3	IFB 70x40		4	2219
IFB4	IFB 70x40		1	1090
IFB5	IFB 70x40		1	2730

Laker Shed B 40 (274x454)

Floor Plan

① Baseboard

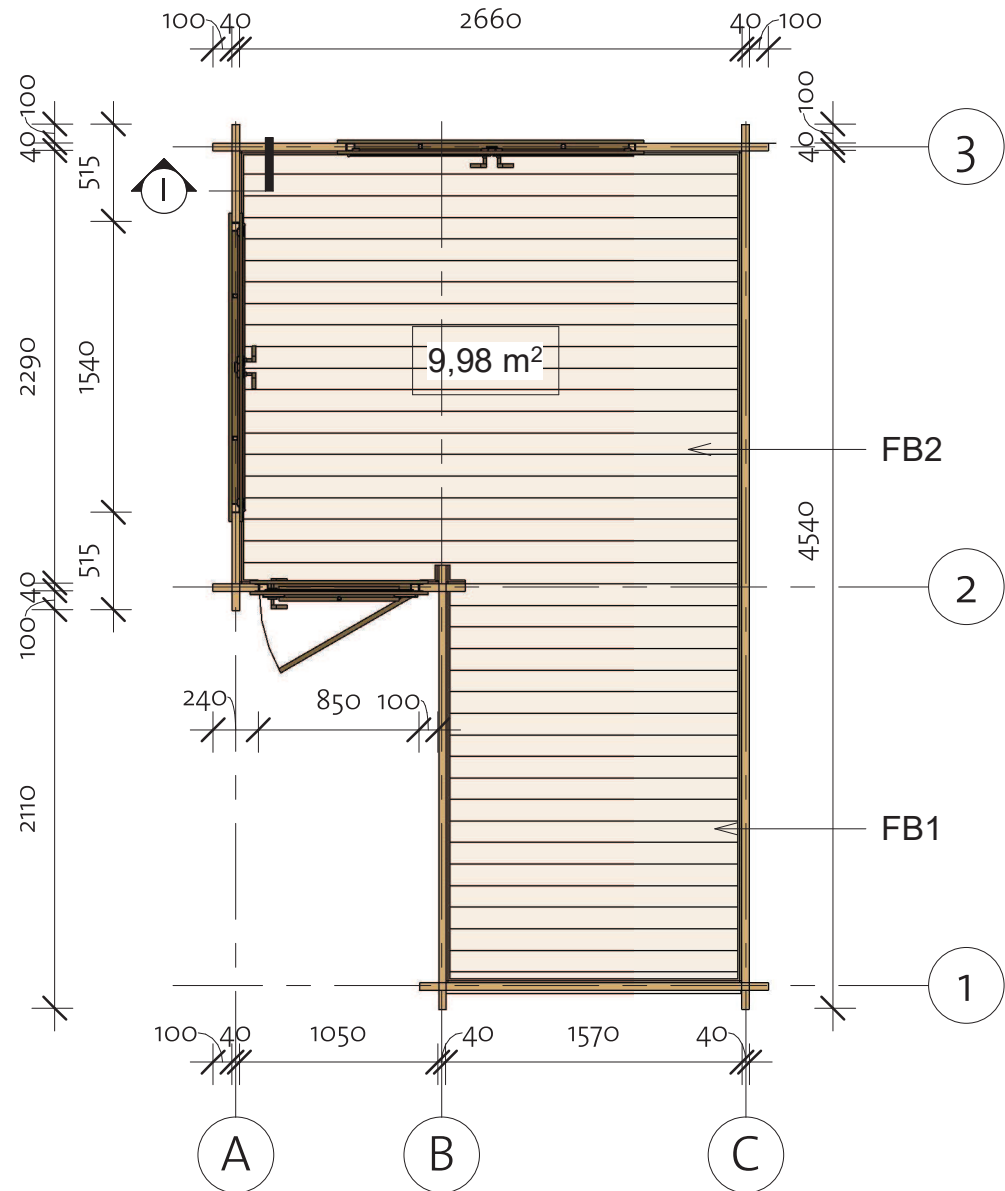
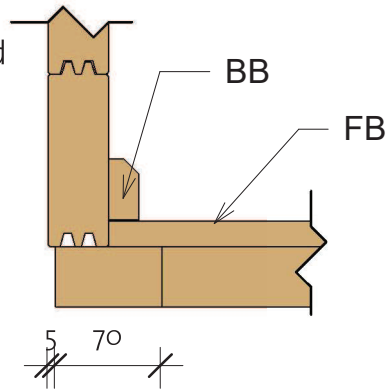

Floor Schedule

Mark	Type	Profile	Count	Length
------	------	---------	-------	--------

FB1	FB 17x114		20	1565
FB2	FB 17x114		21	2655
FB3	FB 17x114		15	2110

BB1	BB 20x40		2	4800
BB2	BB 20x40		2	4300
BB3	BB 20x40		2	3000

91903251_200226

Laker Shed B 40 (274x454)

Wall 1

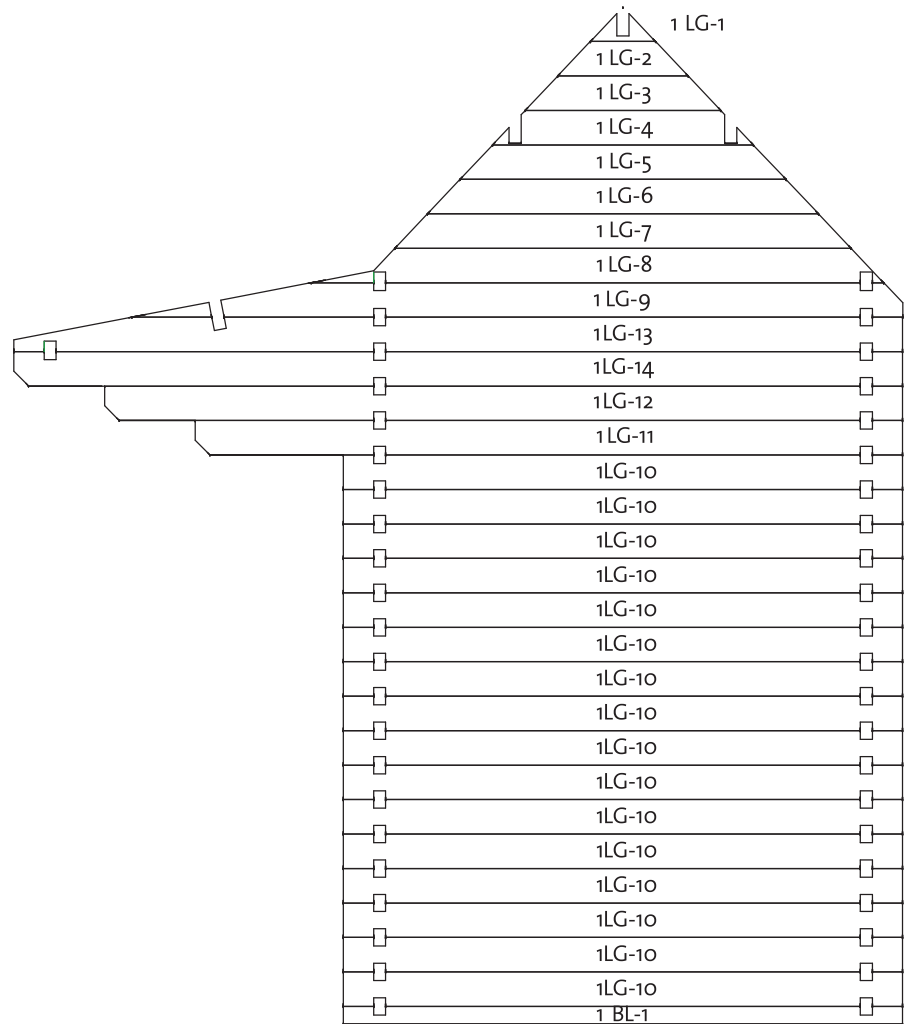

Wall 1			
Mark	Profile	Count	Cut Length

1BL-1	40x57	1	1850
1LG-1 *	40x114	1	216
1LG-2*	40x114	1	431
1LG-3*	40x114	1	647
1LG-4*	40x114	1	863
1LG-5*	40x114	1	1078
1LG-6*	40x114	1	1294
1LG-7*	40x114	1	1509
1LG-8*	40x114	1	1894
1LG-9	40x114	1	2550
1LG-10	40x114	16	1850
1LG-11	40x114	1	2340
1LG-12	40x114	1	2640
1LG-13	40x114	1	2940
1LG-14	40x114	1	2940

* Gable - delivered premounted

Log Profile Wall 1	
Profile	Profile

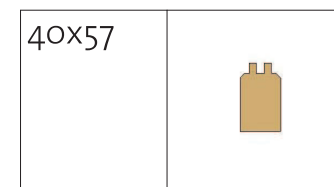

Log Profile Wall 1	
Profile	Profile

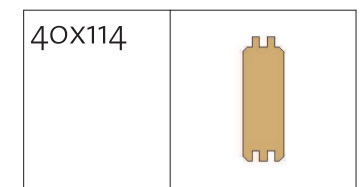

Laker Shed B 40 (274x454)

Wall 2

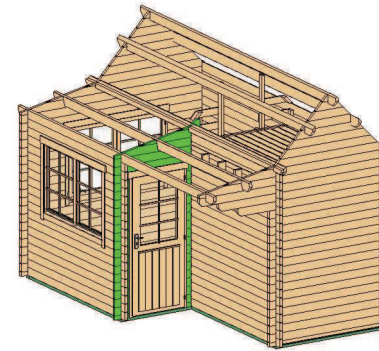

Wall 2			
Mark	Profile	Count	Cut Length

2BL-1	40X57	2	240
2LG-1	40X114	1	940
2LG-2	40X114	34	240
2LG-3	40X114	1	1330
2LG-4	40X114	1	2940
2LG-5	40X114	1	2940
2LG-6	40X114	1	346

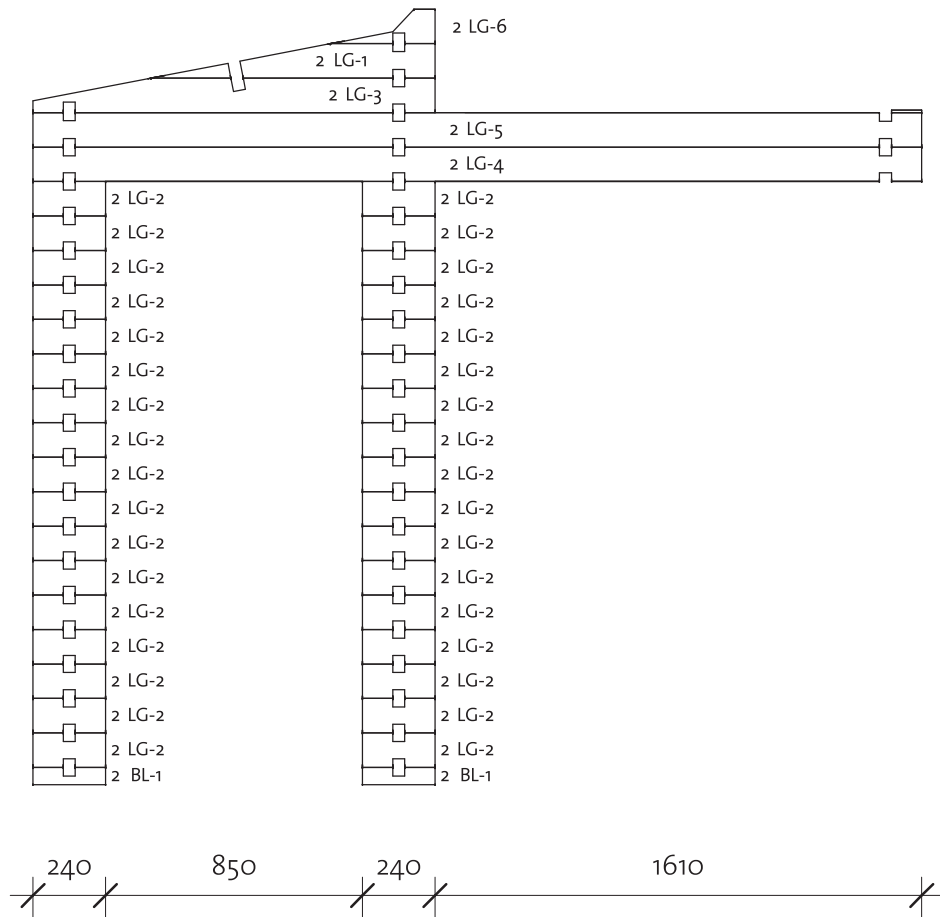

Log Profile Wall 2	
Profile	Profile

40X57	
-------	---

Log Profile Wall 2	
Profile	Profile

40X114	
--------	---

40X114	
--------	---

Laker Shed B 40 (274x454)

Wall 3

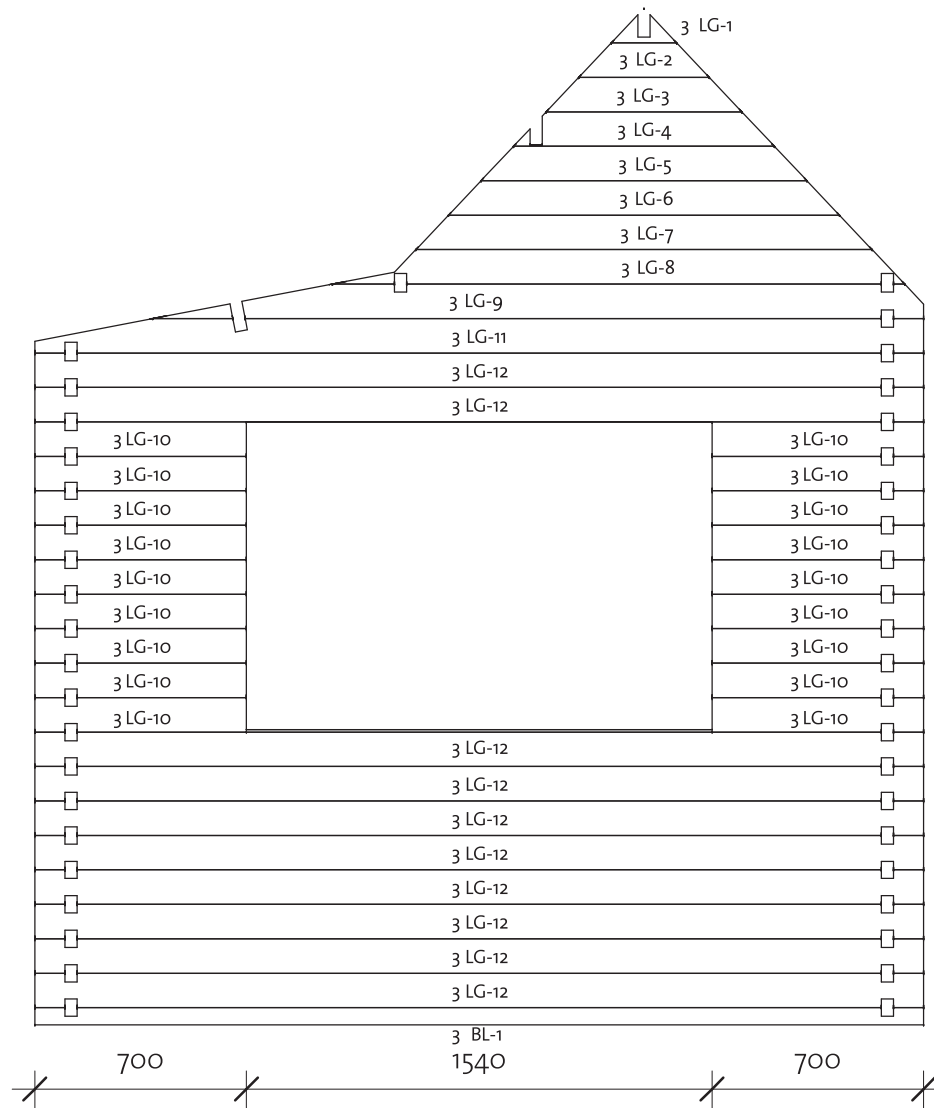
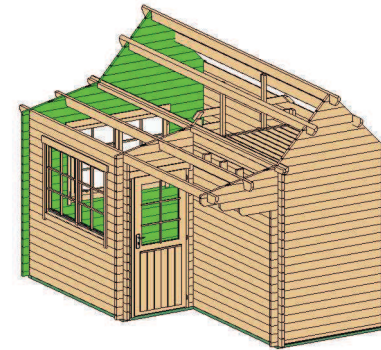

Wall 3			
Mark	Profile	Count	Cut Length

3BL-1	40x57	1	2940
3LG-1*	40x114	1	216
3LG-2*	40x114	1	431
3LG-3*	40x114	1	647
3LG-4*	40x114	1	863
3LG-5*	40x114	1	1078
3LG-6*	40x114	1	1294
3LG-7*	40x114	1	1509
3LG-8*	40x114	1	1894
3LG-9	40x114	1	2550
3LG-10	40x114	18	700
3LG-11	40x114	1	2940
3LG-12	40x114	10	2940

* Gable - delivered premounted

Log Profile Wall 3	
Profile	Profile

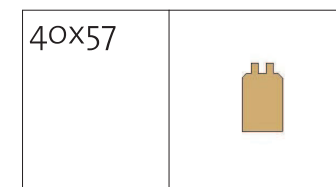

Log Profile Wall 3	
Profile	Profile

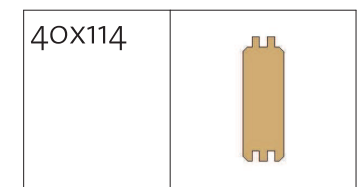

Laker Shed B 40 (274x454)

Wall A

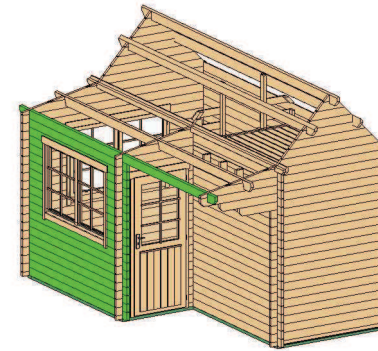

Wall A			
Mark	Profile	Count	Cut Length

ALG-1	40x114	16	515
ALG-2	40x114	9	2570
ALG-3	40x114	1	2570
ALG-4	40x114	1	2570
ATL-1	40x123	1	4880

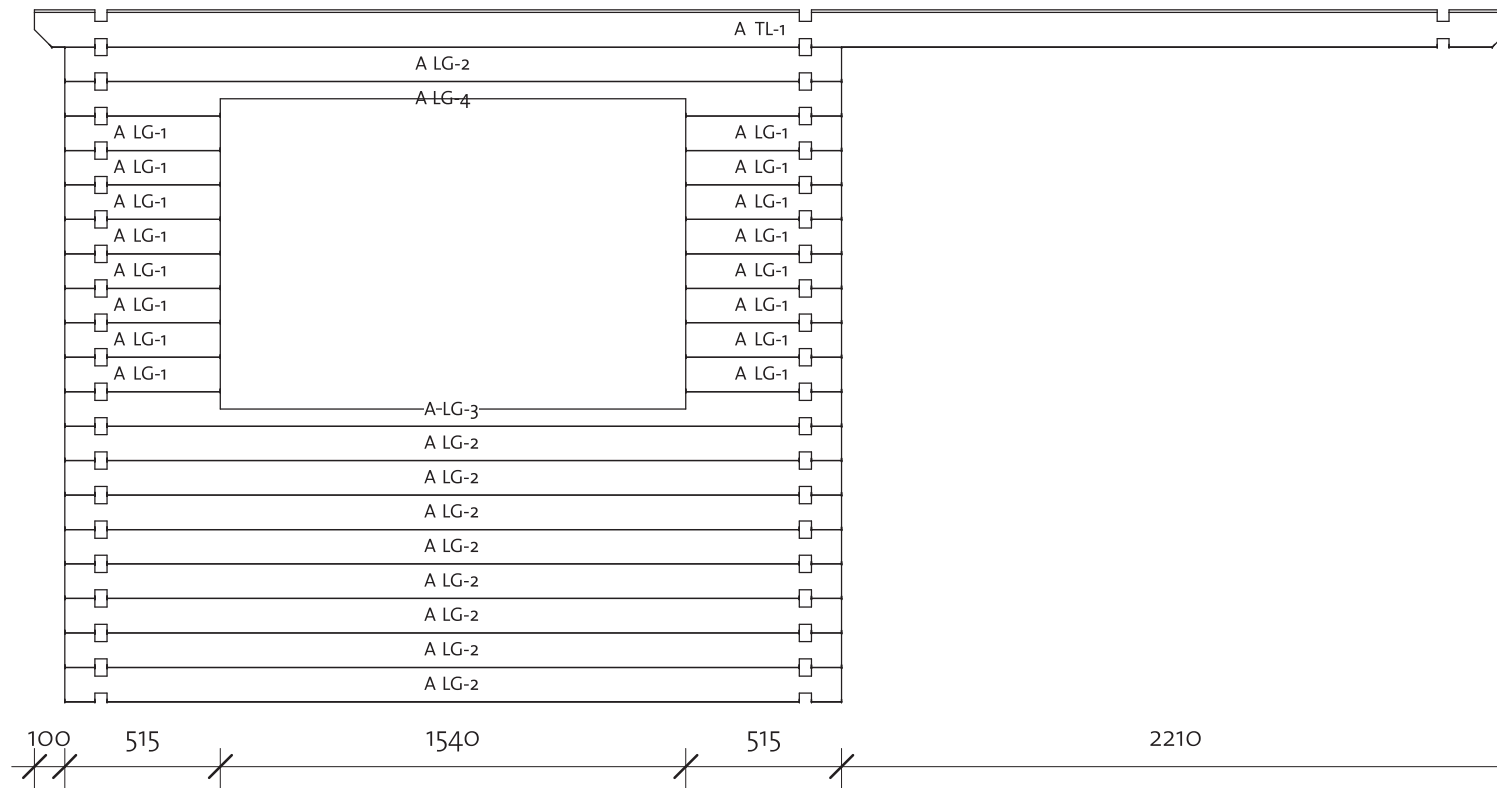

Log Profile Wall A	
Profile	Profile

40x114	
40x123	

Laker Shed B 40 (274x454)

Wall B



Wall B			
Mark	Profile	Count	Cut Length

BLG-1	40X114	19	2350
BLG-2	40X114	1	2350
BLG-3	40X114	1	2350
BTL-1	40X123	1	4880

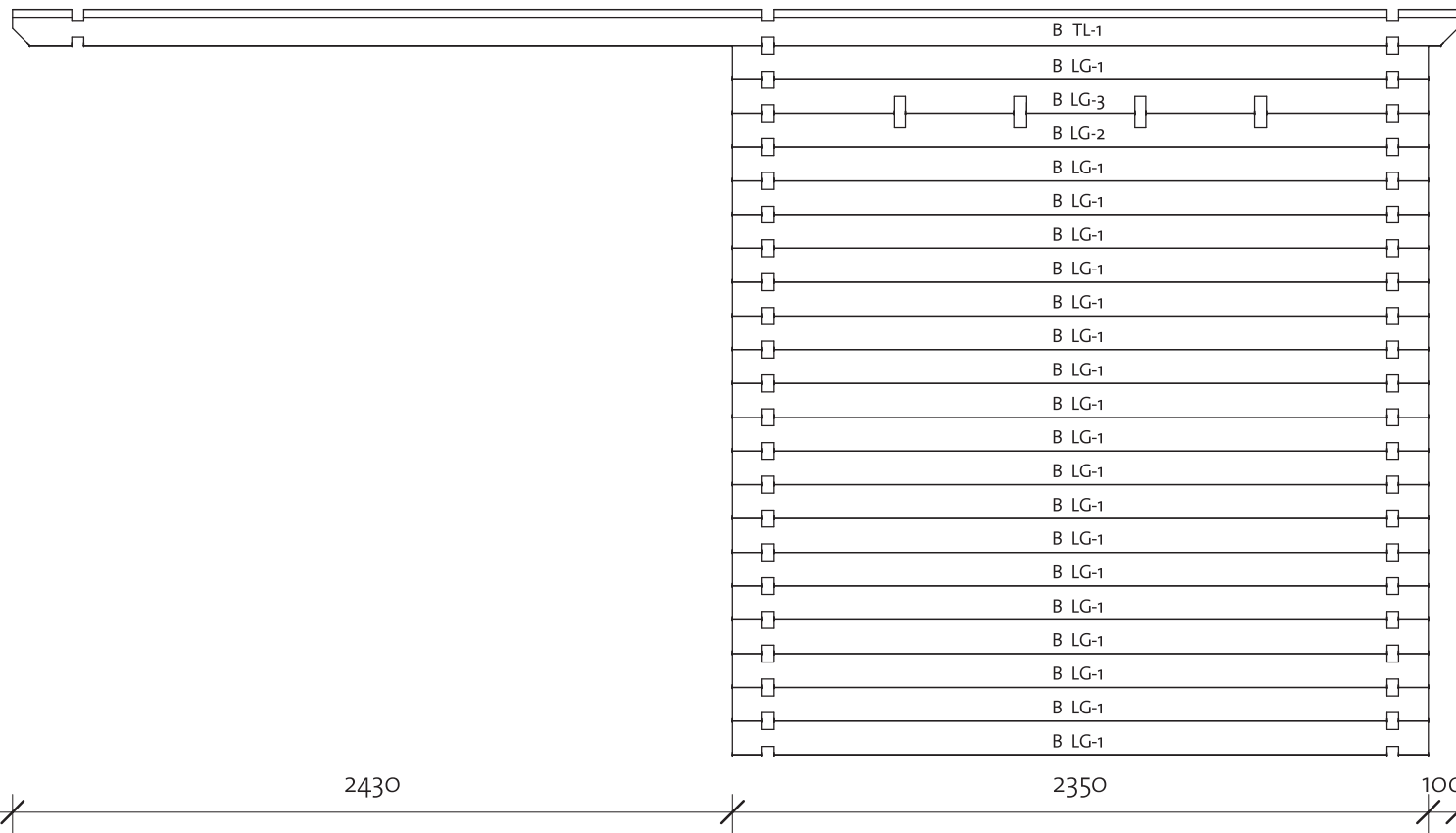

Log Profile Wall B	
Profile	Profile

40X114	
40X123	

Laker Shed B 40 (274x454)

Roof 1

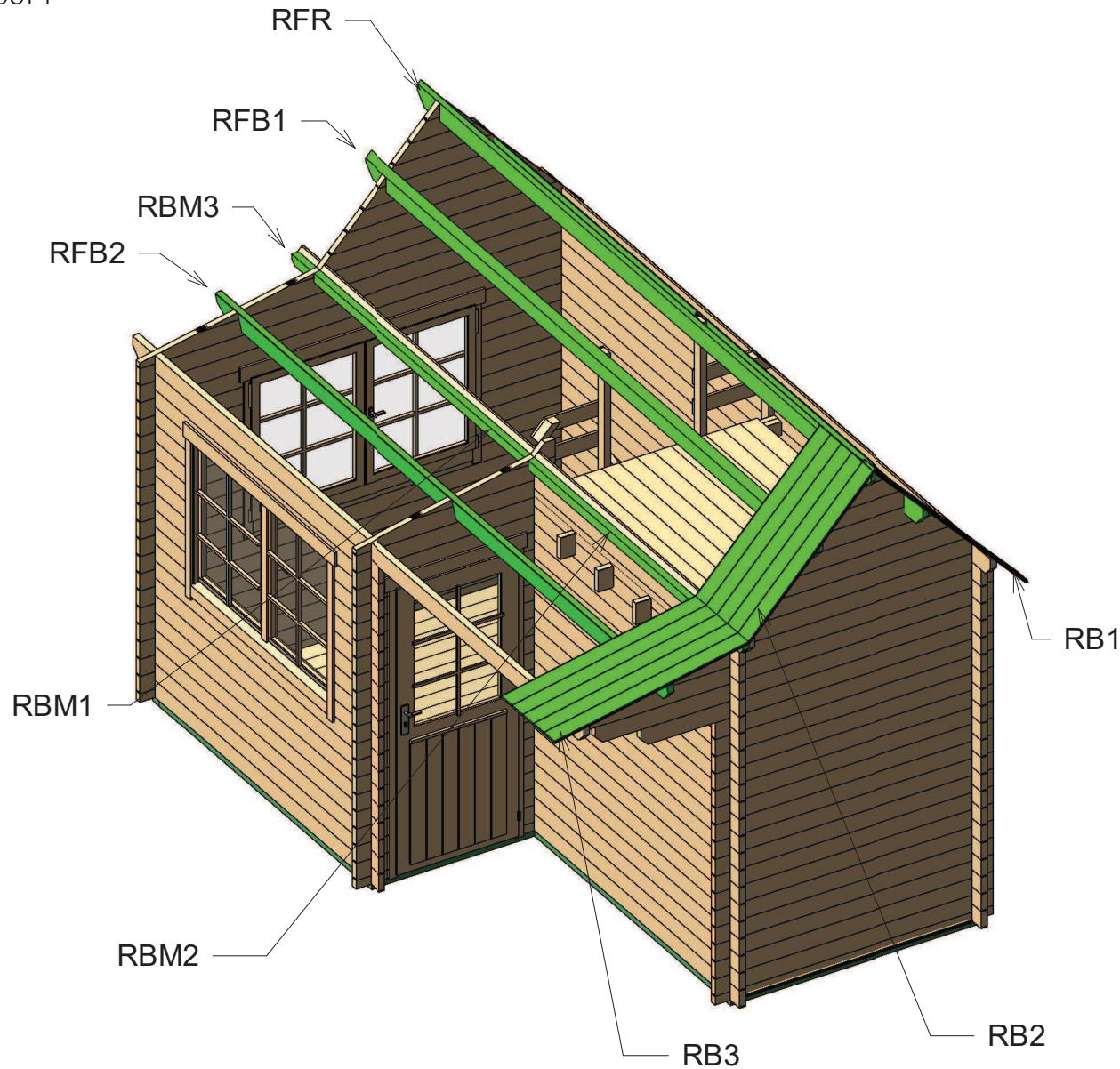

Roof				
Mark	Type	Profile	Count	Cut Length
RB1	17x114		44	1492
RB2	17x114		44	1195
RB3	17x114		44	1308
RBM1	Roof beam 40x70		1	2290
RBM2	Roof beam 40x70		1	2070
RBM3	Roof beam 40x70		1	200
RBM4	Roof beam 40x70		1	200
RFB1	Beam 40x143		2	4880
RFB2	Beam 40x143		1	4880
RFR	Ridge 40x143		1	4880

Laker Shed B 40 (274x454)

Roof 2

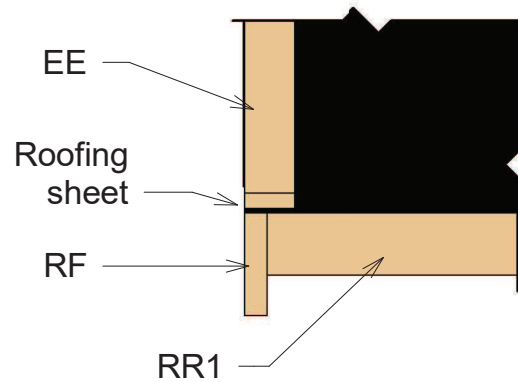
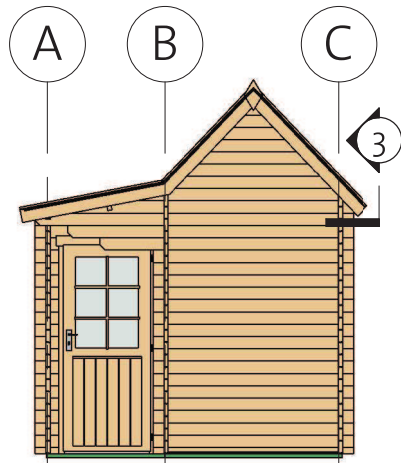
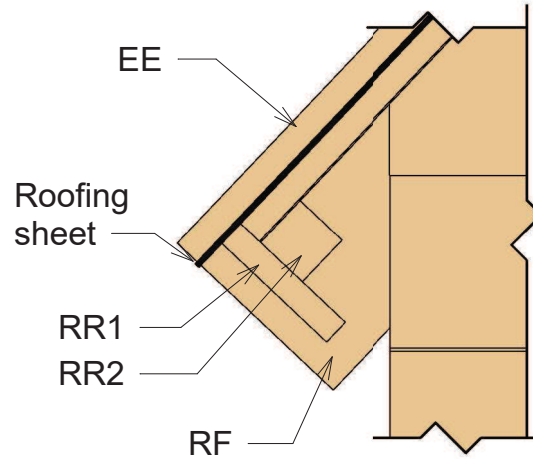
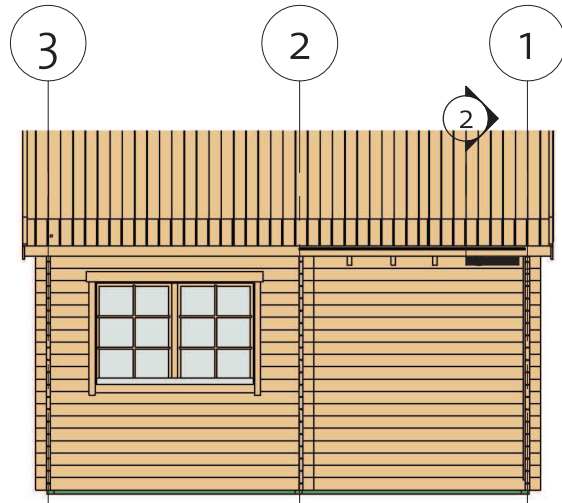

Fascia Schedule				
Mark	Type	Profile	Count	Length

EE1	Eave Edging 18x40		2	1530
EE2	Eave Edging 18x40		2	1237
EE3	Eave Edging 18x40		2	1342
RF1	Roof Fascia 18x120		2	1530
RF2	Roof Fascia 18x120		2	1253
RF3	Roof Fascia 18x120		2	1381
RR1	Roof reinforcement 18x95		2	4880
RR2	Roof reinforcement 38x38		2	4880

Laker Shed B 40 (274x454)

Second floor

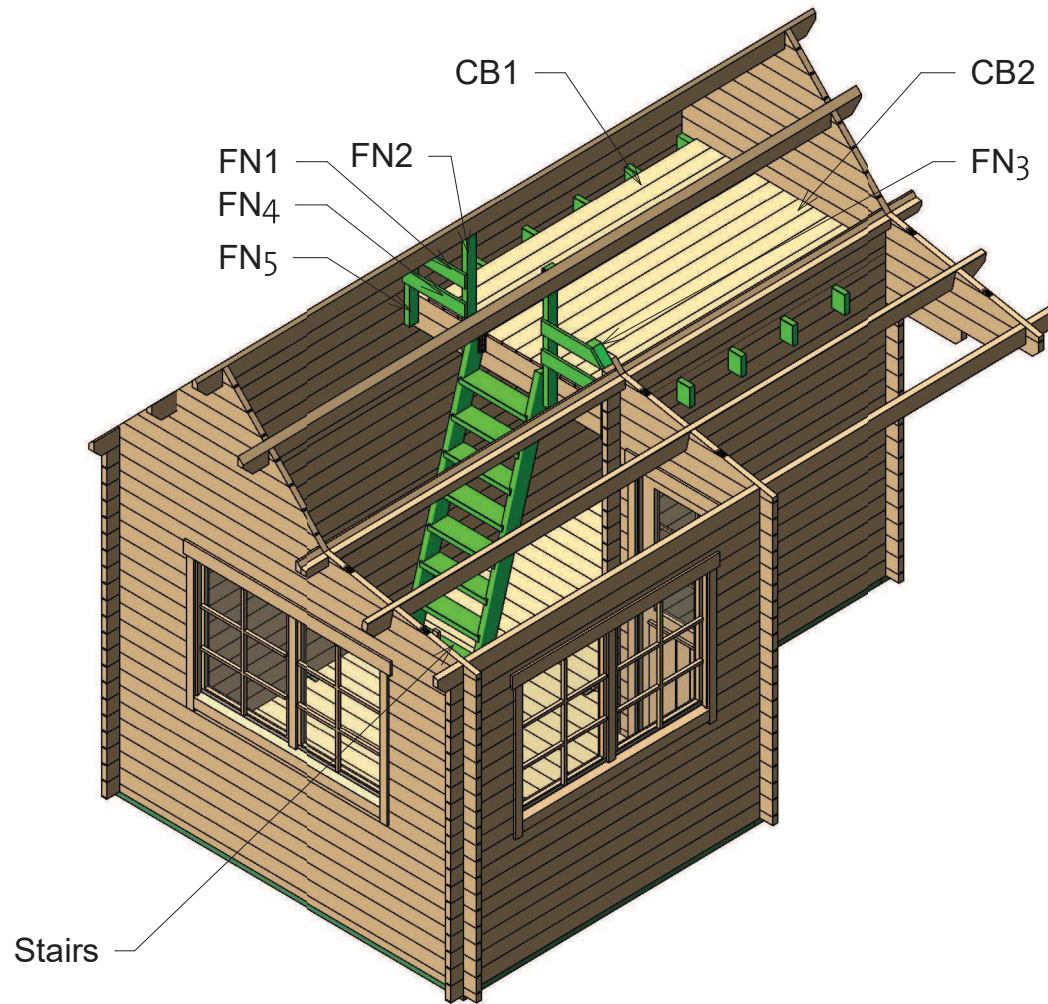

Second floor				
Mark	Type	Profile	Count	Cut Length

CB2	Ceiling beam 40x90		2	1567
CB1	Ceiling beam 40x143		4	1850
FN1	Fence 18x95		2	475
FN4	Fence 18x95		2	488
FN2	Fence 40x70		2	950
FN3	Fence 40x70		2	169
FN5	Fence 40x70		2	399

Laker Shed B 40 (274x454)

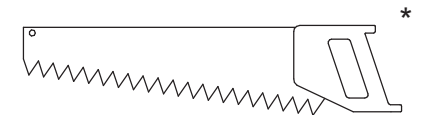
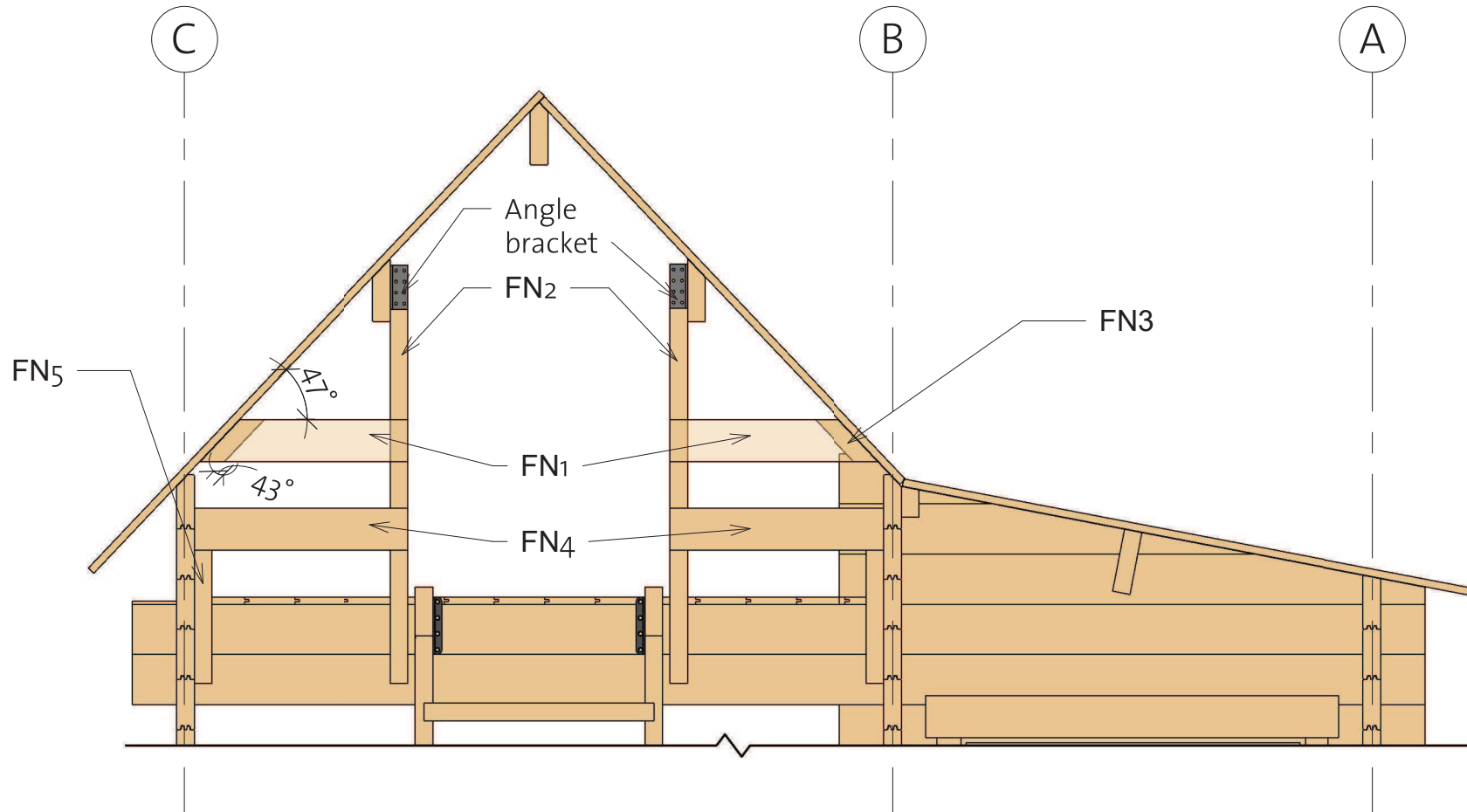

Fence

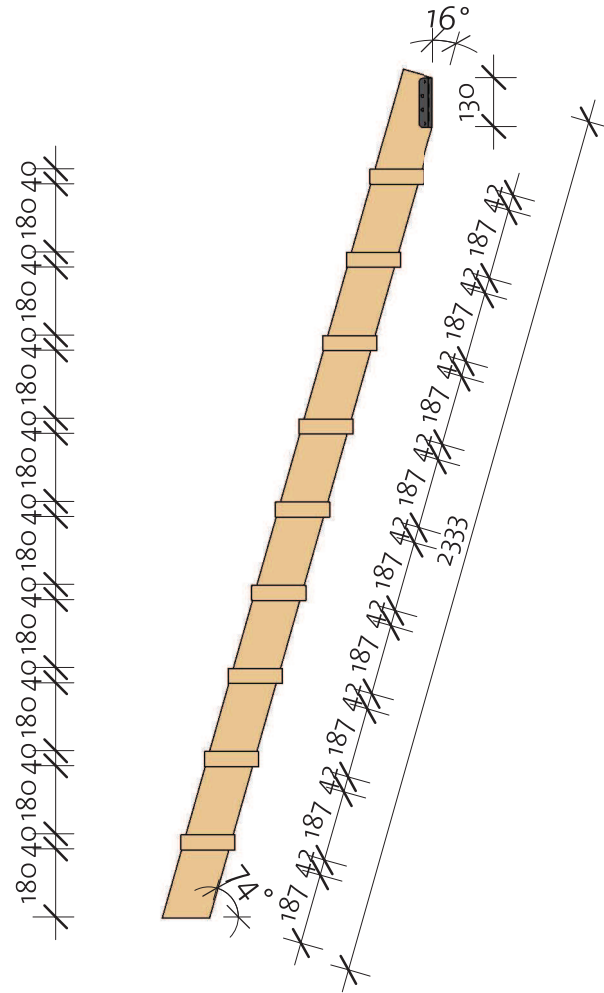
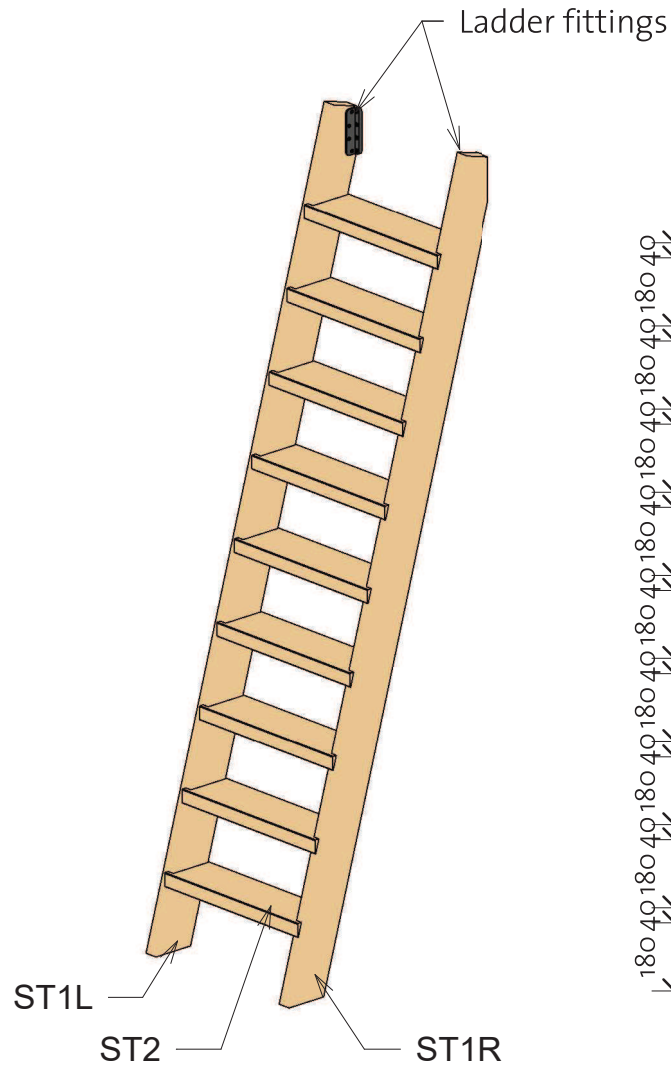

Laker Shed B 40 (274x454)

Stair



Stair				
Mark	Profile	Profile	Count	Cut Length
ST1R	Stair 40X120		1	2333
ST1L	Stair 40X120		1	2333
ST2	Stair 143X40		9	520

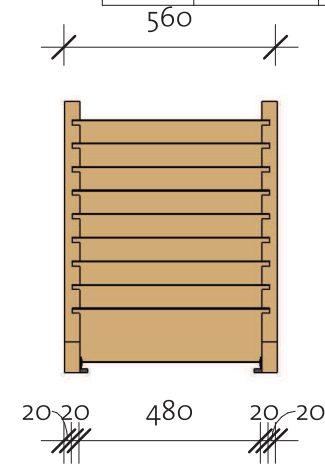

Laker Shed B 40 (274x454)

























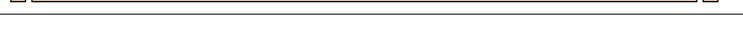

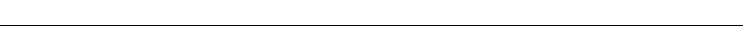

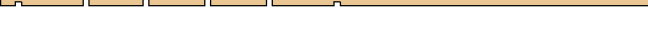

To make the house higher

Extra logs				
Wall	Mark	Profile	Count	Cut Length

1	EX LG-10	Log 40x114	1	1850
2	EX LG-4	Log 40x114	1	2940
3	EX LG-12	Log 40x114	1	2940
A	EX LG-2	Log 40x114	1	2570
B	EX LG-1	Log 40x114	1	2350
C	EX LG-1	Log 40x114	1	4680



























Laker Shed B 40 (274x454)

List of all items 1

	RFB1	Beam 40X143			2	4880
	RFB2	Beam 40X143			1	4880
	RFR	Ridge 40X143			1	4880
A	TL-1	Log 40X123			1	4880
B	TL-1	Log 40X123			1	4880
C	TL-1	Log 40X123			1	4880
C	EX LG-1	Log 40X114			1	4680
C	LG-1	Log 40X114			17	4680
C	LG-1	Log 40X114			1	4680
C	LG-2	Log 40X114			1	4680
C	LG-3	Log 40X114			1	4680
C	LG-4	Log 40X114			1	4680
	IFB2	IFB 70X40			5	4330
3	BL-1	Log 40X57			1	2940
2	EX LG-4	Log 40X114			1	2940
3	EX LG-12	Log 40X114			1	2940
2	LG-4	Log 40X114			1	2940
2	LG-5	Log 40X114			1	2940
3	LG-11	Log 40X114			1	2940
3	LG-12	Log 40X114			10	2940
1	LG-13	Log 40X114			1	2940
1	LG-14	Log 40X114			1	2940
91903251_201023	IFB5	IFB 70X40			1	2730



















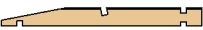



Laker Shed B 40 (274x454)

List of all items 2

	FB2	FB 17x114			21	2655
1	LG-12	Log 40x114			1	2640
A	EX LG-2	Log 40x114			1	2570
A	LG-2	Log 40x114			9	2570
A	LG-3	Log 40x114			1	2570
A	LG-4	Log 40x114			1	2570
1	LG-9	Log 40x114			1	2550
3	LG-9	Log 40x114			1	2550
B	EX LG-1	Log 40x114			1	2350
B	LG-1	Log 40x114			19	2350
B	LG-2	Log 40x114			1	2350
B	LG-3	Log 40x114			1	2350
1	LG-11	Log 40x114			1	2340
tre pp	ST1L	Stair 40x120 L			1	2333
tre pp	ST1R	Stair 40x120 R			1	2333
	RBM1	Roof beam 40x70			1	2290
	IFB3	IFB 70x40			4	2219
	FB3	FB 17x114			15	2110
	RBM2	Roof beam 40x70			1	2070

Laker Shed B 40 (274x454)

List of all items 3

1	BL-1	Log 40x57		1	1850
	CB1	Ceiling beam 40x143		4	1850
1	EX LG-10	Log 40x114		1	1850
1	LG-10	Log 40x114		16	1850
	IFB1	IFB 70x40		1	1640
	CB2	Ceiling beam 40x90		2	1567
	FB1	FB 17x114		20	1565
	RB1	17x114		44	1492
2	LG-3	Log 40x114		1	1330
	RB3	17x114		44	1308
	RB2	17x114		44	1195
	IFB4	IFB 70x40		1	1090
	FN2	Fence 40x70		2	950
2	LG-1	Log 40x114		1	940
3	LG-10			18	700
tre pp	ST2	Stair 143x40		9	520
A	LG-1	Log 40x114		16	515
	FN4	Fence 18x95		2	488
	FN1	Fence 18x95		2	475
	FN5	Fence 40x70		2	399
2	LG-6	Log 40x114		1	346
2	BL-1	HalfLog 40x57		2	240
2	LG-2	Log 40x114		34	240

① Gable 1

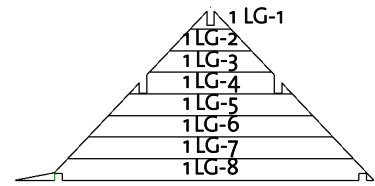

② Gable 3

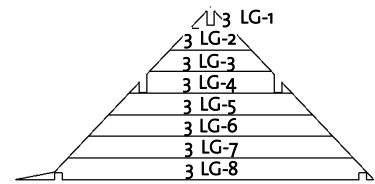

Laker Shed B 40 (274x454)

List of all items 4

BB1	BB 20x40			2	4800
BB2	BB 20x40			2	4300
BB3	BB 20x40			2	3000



Windboard 18x40				5	2640
-----------------	---	--	--	---	------

Romb	2	
------	---	---

CD4R	Classic door 4 right	840	1955	1
------	----------------------	-----	------	---











DCB6	Door Crossbar 6	--	--	1
------	-----------------	----	----	---

	RBM3	Roof beam 40x70		2	200
	FN3	Fence 40x70		2	169





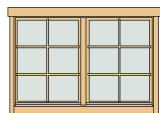

CDW1	Classic double window 1	990	1530	2
------	-------------------------	-----	------	---

Fascia Schedule				
Mark	Type	Profile	Count	Length

EE1	Eave Edging 18x40		2	1530
EE2	Eave Edging 18x40		2	1237
EE3	Eave Edging 18x40		2	1342
RF1	Roof Fascia 18x120		2	1530
RF2	Roof Fascia 18x120		2	1253
RF3	Roof Fascia 18x120		2	1381
RR1	Roof reinforcement 18x95		2	4880
RR2	Roof reinforcement 38x38		2	4880

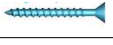
WCB6	Windows Crossbar 6	--	--	4
------	--------------------	----	----	---



Hitblock	300-400 mm		
Ladder fittings			2
Angle bracket			2
Screws	5,0 x 40		12
Bolts	M8x70		15
Screws	5,0 x 70		70
Nails	1,4 x 40		70
Screws	6,0 x 140		120
Screws	4,0 x 40		150
Screws	4,0 x 50		850

91903251_201023